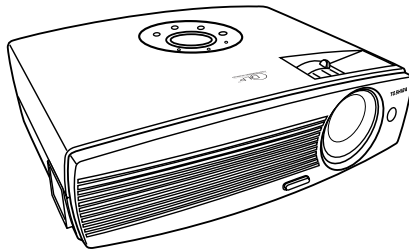


TOSHIBA

Owner's Manual
DATA Projector

TDP-P75



SAFETY PRECAUTION



The lightning flash with arrowhead symbol, within an equilateral triangle, is intended to alert the user to the presence of uninsulated "dangerous voltage" within the product's enclosure that may be of sufficient magnitude to constitute a risk of electric shock to persons.



The exclamation point within an equilateral triangle is intended to alert the user to the presence of important operating and maintenance (servicing) instructions in the literature accompanying the appliance.

WARNING: TO REDUCE THE RISK OF FIRE OR ELECTRIC SHOCK, DO NOT EXPOSE THIS APPLIANCE TO RAIN OR MOISTURE. DANGEROUS HIGH VOLTAGES ARE PRESENT INSIDE THE ENCLOSURE. DO NOT OPEN THE CABINET. REFER SERVICING TO QUALIFIED PERSONNEL ONLY.

WARNING: Handling the cord on this projector, or the cords associated with accessories sold with this projector, will expose you to lead, a chemical known to the State of California to cause birth defects or other reproductive harm. ***Wash hands after handling.***

USA only

WARNING: The lamp used in this projector contains mercury. Disposal of mercury may be regulated due to environmental considerations. For disposal or recycling information, please contact your local authorities or the Electronic Industries Alliance: www.eiae.org.

USA only

MODEL NAME: TDP-P75

USA only

TRADE NAME: DATA PROJECTOR

MODEL NAME: TDP-P75



Tested To Comply
With FCC Standards

FOR HOME OR OFFICE USE

FCC NOTICE: This device complies with part 15 of the FCC Rules. Operation is subject to the following two conditions:

(1) This device may not cause harmful interference, and (2) this device must accept any interference received, including interference that may cause undesired operation. This equipment has been tested and found to comply with the limits for a Class B digital device, pursuant to part 15 of the FCC Rules. These limits are designed to provide reasonable protection against harmful interference in a residential installation. This equipment generates, uses and can radiate radio frequency energy and, if not installed and used in accordance with the instructions, may cause harmful interference to radio communications.

However, there is no guarantee that interference will not occur in a particular installation. If this equipment does cause harmful interference to radio or television reception, which can be determined by turning the equipment off and on, the user is encouraged to try to correct the interference by one or more of the following measures:

- Reorient or relocate the receiving antenna.
- Increase the separation between the equipment and receiver.
- Connect the equipment into an outlet on a circuit different from that to which the receiver is connected.
- Consult the dealer or an experienced radio/TV technician for help.

RESPONSIBLE PARTY: TOSHIBA AMERICA INFORMATION SYSTEMS, INC.

9470 Irvine Blvd., Irvine, CA 92618-1697 U.S.A

Phone: (949) 583-3000

WARNING: Changes or modifications made to this equipment, not expressly approved by Toshiba, or parties authorized by Toshiba, could void the user's authority to operate the equipment.

USA only

Notice: This Class B digital apparatus complies with Canadian ICES-003. Cet

appareil numérique de la classe B est conforme à la norme NMB-003 du Canada.

CANADA only

IMPORTANT SAFETY INSTRUCTIONS

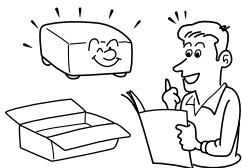
CAUTION: PLEASE READ AND OBSERVE ALL WARNINGS AND INSTRUCTIONS GIVEN IN THIS OWNER'S MANUAL AND THOSE MARKED ON THE UNIT. RETAIN THIS BOOKLET FOR FUTURE REFERENCE.

This set has been designed and manufactured to ensure personal safety. Improper use can result in electric shock or fire hazard. The safeguards incorporated in this unit will protect you if you observe the following procedures for installation, use and servicing. This unit is fully transistorized and does not contain any parts that can be repaired by the user.

DO NOT REMOVE THE CABINET COVER OR YOU MAY BE EXPOSED TO DANGEROUS VOLTAGE. REFER SERVICING TO QUALIFIED SERVICE PERSONNEL ONLY.

1. Read owner's manual

After unpacking this product, read the owner's manual carefully, and follow all the operating and other instructions.



2. Power sources

This product should be operated only from the type of power source indicated on the marking label. If you are not sure of the type of power supply to your home, consult your product dealer or local power company. For products intended to operate from battery power or other sources, refer to the operating instructions.



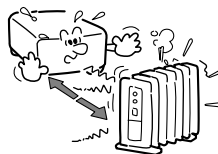
3. Source of light

Do not look into the lens while the lamp is on. The strong light from the lamp may cause damage to your eyes or sight.



4. Heat

The product should be situated away from heat sources such as radiators, heat registers, stoves, or other products (including amplifiers) that produce heat.



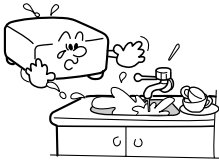
5. Ventilation

Openings in the cabinet are provided for ventilation to ensure reliable operation of the product and protect it from overheating. These openings must not be blocked or covered. The openings should never be blocked by placing the product on a bed, sofa, rug or other similar surface. This product should not be placed in a built-in installation such as a bookcase or rack unless proper ventilation is provided or the manufacturer's instructions have been adhered to.



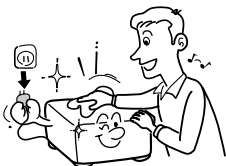
6. Water and moisture

Do not use this product near water (for example, near a bath tub, wash bowl, kitchen sink, or laundry tub; in a wet basement; or near a swimming pool).



7. Cleaning

Unplug this product from the wall outlet before cleaning. Do not use liquid cleaners or aerosol cleaners. Use a soft cloth for cleaning.



8. Power cord protection

Power-supply cords should be routed so that they are not likely to be walked on or pinched by items placed upon or against them, paying particular attention to cords at plugs, convenience receptacles, and the point where they exit from the product.



9. Overloading

Do not overload wall outlets; extension cords, or integral convenience receptacles as this can result in a risk of fire or electric shock.



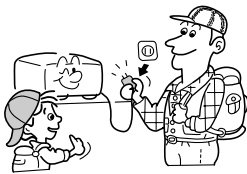
10. Object and liquid entry

Never push objects of any kind into this product through the openings, as they may touch dangerous voltage points or short-out parts that could result in a fire or electric shock. Never spill liquid of any kind on the product.



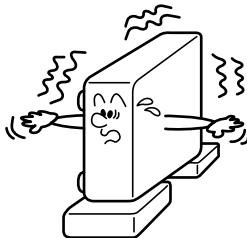
11. Lightning storms

For added protection for this product during a storm, or when it is left unattended and unused for long periods of time, unplug it from the wall outlet. This will prevent damage to the product due to lightning and power line surges. However, while it is thundering or lightning, do not touch the apparatus and any connected cable and/or equipment. This will prevent you from receiving the electric shock by an electric surge.



12. Do not place the product vertically.

Do not use the product in the upright position to project pictures at the ceiling, or any other vertical positions. The product may fall over, causing personal injury or product damage.



13. Attachments

Do not use attachments not recommended by the product manufacturer, as they may cause hazards.

14. Do not stack components.

Do not stack other equipment on this product or stack this product on other equipment. The top and bottom surfaces of this product develop heat and may damage the other unit.



15. Accessories

Do not place this product on an unstable cart, stand, tripod, bracket, or table. The product may fall, causing serious injury to a child or adult, and serious damage to the product. A product and cart combination should be moved with care. Quick stops, excessive force, and uneven surfaces may cause the product and cart combination to overturn.



S3125A

16. Damage requiring service

Unplug this product from the wall outlet and refer servicing to qualified service personnel under the following conditions:

- a) when the power-supply cord or plug is damaged;
- b) if liquid has been spilled or objects have fallen into the product;
- c) if the product has been exposed to rain or water;
- d) if the product does not operate normally by following the operating instructions (adjust only those controls that are covered by the operating instructions as an improper adjustment of other controls may result in damage and will often require extensive work by a qualified technician to restore the product to its normal operation);
- e) if the product has been dropped or damaged in any way; or
- f) when the product exhibits a distinct change in performance.

17. If glass components, including the lens and lamp, should break, contact your dealer for repair service.

This product incorporates glass components, including the lens and lamp. If such parts should break, please handle with care to avoid injury. Contact your dealer for repair service. The broken pieces of glass may cause injury. In the unlikely event of the lamp rupturing, thoroughly clean the area around the projector and discard any edible items placed in that area.

18. Servicing

Do not attempt to service this product yourself, as opening or removing covers may expose you to dangerous voltage or other hazards. Refer all servicing to qualified service personnel.

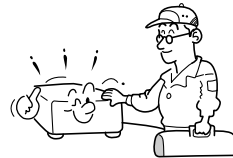


19. Replacement parts

When replacement parts are required, be sure the service technician has used replacement parts specified by the manufacturer or that have the same characteristics as the original part. Unauthorized substitutions may result in fire, electric shock, or other hazards. (The lamp is the only user-replaceable part.)

20. Safety check

Upon completion of any service or repairs to this product, ask the service technician to perform safety checks to determine that the product is in proper operating condition.



- 21. Do not leave thermal-paper documents or easily deformed items on top of the unit or near the air exhaust for long periods of time.**

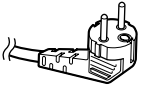
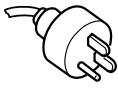
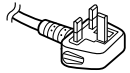
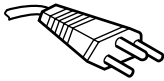
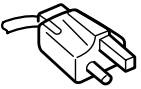
The heat from the unit could erase the information on the thermal paper, or cause deformation or warping.

- 22. Do not use the product in a closed installation state.**

Do not place the product in a box or in any other closed installation state. Otherwise it may overheat. This could result in a risk of fire.

POWER SUPPLY CORD SELECTION

If your line voltage is 220 to 240V, use one of the following types of cable.

Plug configuration	Plug type	Line voltage	Plug configuration	Plug type	Line voltage
	EURO	220 - 240V		Australian 240V 10A	200 - 240V
	UK	220 - 240V		Switzerland 240V 6A	200 - 240V
Use a 5A fuse approved by ASTA or BSI to BSI362. Always replace the fuse cover after changing the fuse.				North American 240V 10A	200 - 240V

IMPORTANT PRECAUTIONS

Save Original Packing Materials

The original shipping carton and packing materials will come in handy if you ever have to ship your projector. For maximum protection, repack the set as it was originally packed at the factory.

Moisture Condensation

Never operate this unit immediately after moving it from a cold location to a warm location. When the unit is exposed to such a change in temperature, moisture may condense on the crucial internal parts. To prevent the unit from possible damage, do not use the unit for at least 2 hours after there is an extreme or sudden change in temperature.

Location and Installation

- Do not place in hot locations, such as near a heater. Doing so could cause malfunction and shorten the life of the projector.
- Avoid locations with oil or cigarette smoke, which can affect the quality and useful life of the product's optical parts and darken the screen.
- Do not use the product vertically in any upright position or slantwise at an angle of 20 degrees or more.
- Using this product near a TV or radio may cause interference in the image or sound. If this happens, move it away from the TV or radio.
- In a high-altitude location where the air is thin, cooling efficiency is reduced; therefore, use the projector in a cool area.

Avoid Volatile Liquids

Do not use volatile liquids, such as an insect spray, near the unit. Do not leave rubber or plastic products touching the unit for a long time. They will leave marks on the finish. If cleaning with a chemically saturated cloth, be sure to follow the product's precautions.

In the spaces provided below, record the model and serial numbers located at the bottom of your projector.

Model No.

Serial No.

Retain this information for future reference.

EXEMPTION CLAUSES

- Toshiba Corporation bears no responsibility in the case of damages arising from natural disaster such as earthquakes, lightning, etc., fire not liable to Toshiba Corporation, acts by third parties, other accidents, or use under abnormal conditions including erroneous or improper operation and other problems.
- Toshiba Corporation bears no responsibility for incidental damages (lost profit, work interruption, corruption or loss of the memory contents, etc.) arising from the use of or the inability to use this unit.
- Toshiba Corporation accepts no liability whatsoever for any damages arising from not having followed the descriptions in this Instruction Manual.
- Toshiba Corporation accepts no liability whatsoever for any damages arising from malfunctions arising from combination with equipment or software that is not related to Toshiba Corporation.

OTHER NOTES AND INFORMATION

Copyrights

Showing or transmitting commercial imaging software or broadcast or cable-broad casting programs with the purpose of other than the personal and private viewing, including modifying images using the freeze or screen size functions, or displaying with the varying aspect ratio of the images, could violate the direct or indirect copyrights of the imaging software or broadcast program, etc., if done without first consulting with the copyright holder. For this reason, please take appropriate measures before performing one of the actions listed above, including obtaining a license from the copyright holder.

Disposal

This product contains substances which are harmful to humans and the environment.

- The lamp contains inorganic mercury.

Please dispose of this product or used lamps in accordance with local regulations.

WEEE Directive

Following information is only for EU-member states:

The use of the symbol indicates that this product may not be treated as household waste. By ensuring this product is disposed of correctly, you will help prevent potential negative consequences for the environment and human health, which could otherwise be caused by inappropriate waste handling of this product. For more detailed information about recycling of this product, please contact your local city office, your household waste disposal service or the shop where you purchased the product.



Trademarks

- VGA, SVGA, XGA are trademarks or registered trademarks of International Business Machines Corporation.
- DLP and Digital Light Processing, Digital Micromirror Device, DMD, and DLP are trademarks of Texas Instruments.
- Macintosh is a registered trademark of Apple Computer, Inc.
- Windows is a registered trademark of Microsoft Corporation in the U.S. and other countries.
- Adobe is a registered trademark and Acrobat Reader is a trademark of Adobe Systems Incorporated.

Notational Conventions Used in This Manual

- References to pages with related information are annotated as follows. For example, if making a reference to page 36: **p.36**
- The illustrations in this document are for reference purposes only and may not reflect your package exactly.

REMOTE CONTROL BATTERIES

Caution

- Never throw batteries into a fire.

Note

- Be sure to use AAA batteries.
- Dispose of batteries in a designated disposal area.
- Attention should be drawn to the environmental aspects of battery disposal.
- Do not mix different battery types or combine used batteries with new ones.
- If the remote control does not operate correctly, or if the operating range becomes reduced, replace both batteries with new ones.
- If the batteries are dead or if you will not be using the remote control for a long time, remove the batteries to prevent battery acid from leaking into the battery compartment.

Using the batteries improperly may cause them to explode or leak and lead to burn or injury. If battery-leaking fluid contacts skin, wash the fluid off immediately with clean water and consult a doctor. If the fluid is spilt on an instrument, avoid contact and wipe it off using tissue paper.

(Dispose of the used tissue paper as flammable garbage after moistening with water.)

Contents

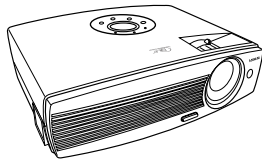
SAFETY PRECAUTION	2
IMPORTANT SAFETY INSTRUCTIONS	4
POWER SUPPLY CORD SELECTION	8
IMPORTANT PRECAUTIONS	9
EXEMPTION CLAUSES	10
OTHER NOTES AND INFORMATION	11
REMOTE CONTROL BATTERIES	12
Overview.....	15
Shipping contents.....	15
Projector exterior view.....	16
Controls and functions	17
Remote control.....	18
Preparing and using the remote control	19
Operating a computer using the remote control	21
Positioning your projector	22
Choosing a location.....	22
Projection distance and size	23
Connection	23
Connecting to a computer	24
Connecting to a Component Video device.....	24
Connecting Video and S-Video devices.....	25
Operation.....	26
Start up.....	26
Adjusting the image.....	27
Adjusting the height.....	27
Auto-adjusting the image	27
Fine-tuning the image size and clarity.....	27
Adjusting the volume.....	28

Correcting keystone	28
Switching input signals	28
Shutdown.....	29
Menu operation.....	30
Menu system	30
Using the menus	31
1. Image adjustment menu	32
2. Display setting menu	33
3. Default setting menu	34
4. Information menu	35
Additional Information	36
Care of the projector	36
Cleaning the lens.....	36
Cleaning the projector case.....	36
Storing the projector	37
Transporting the projector	37
About the lamp.....	37
Lamp warning message.....	38
Replacing the lamp	38
Indicator lights.....	40
Troubleshooting	41
Specifications	42
Projector specifications.....	42
Dimensions.....	43
Signal timing.....	43
Regulation statements	45
FCC statement	45
EEC statement	45
MIC statement	45

Overview

Shipping contents

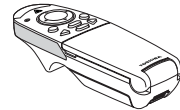
The projector is shipped with a cable required for connection to a PC. Carefully unpack and verify that you have all of the items shown below. If any of these items are missing, please contact your place of purchase.



Projector



Soft carry case



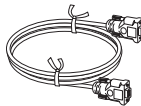
Remote control



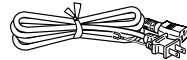
Batteries



Mouse remote control receiver



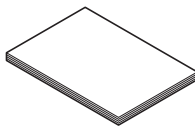
VGA cable



Power cord*



Owner's manual CD



Owner's manual

*The supplied power cord will be suitable for your region, and may differ from that illustrated.

◆ The Supplied CD-ROM

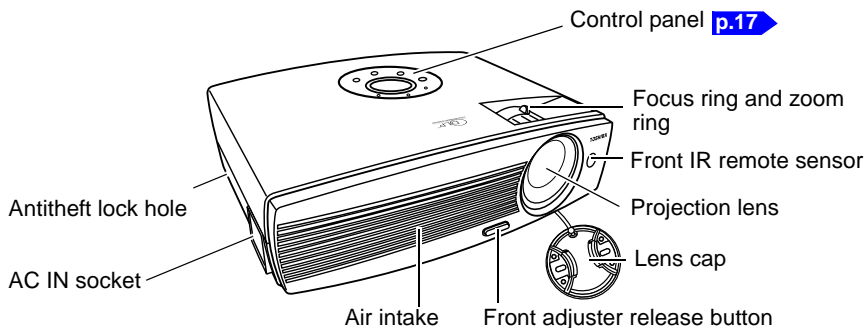
The supplied CD-ROM contains an owner's manual, including information not available for the printed Owner's Manual (Getting started) and Acrobat® Reader™ to view the manual.

■ Viewing the manual

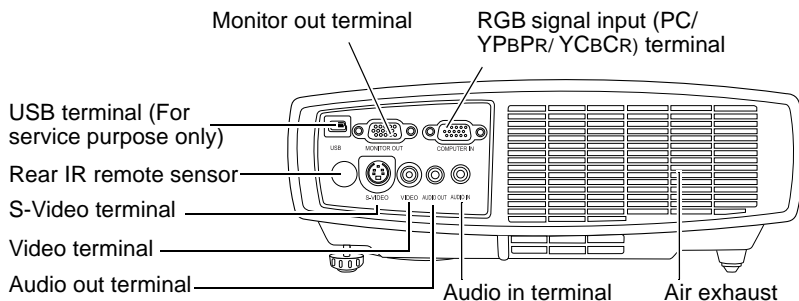
Run the CD-ROM and double-click on **Start.pdf**. Acrobat® Reader™ launches, and the menu screen of the Owner's manual appears. Click on your language. The Owner's Manual cover and list of bookmarks appear. Click on a bookmark title to view that section of the manual. Click on **p.** to view a reference page with related information. See the Help menu for more information about Acrobat® Reader™.

Projector exterior view

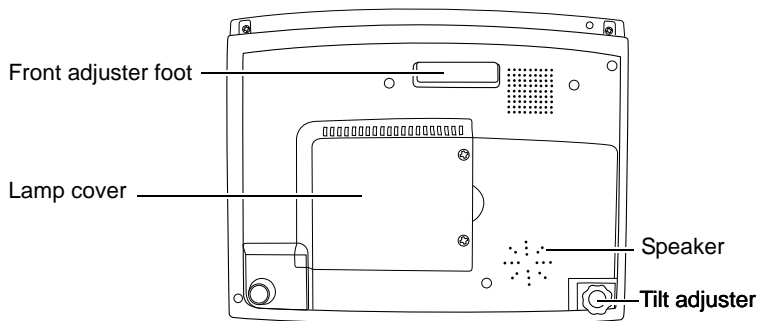
Front / Upper side



Rear side

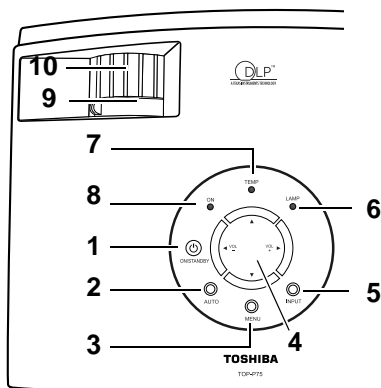


Bottom side



Controls and functions

Control panel

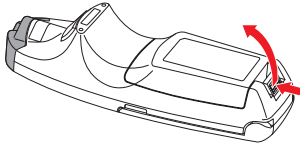


1. **ON/STANDBY button** [p.26](#)
[p.29](#)
Turns the projector on or off.
2. **AUTO button** [p.27](#)
Automatically determines the best picture settings for the displayed image.
3. **MENU button**
Opens, saves and exits the on-screen menu.
4. **▼, ▲, ◀, ▶ button**
The directional buttons are used to select the desired menu items and to make adjustments when the on-screen menu is activated.
When the on-screen menu is not activated, the ◀ and ▶ buttons function as **VOLUME decrease -** and **VOLUME increase +** hot keys. ([p.27](#))
5. **INPUT button** [p.28](#)
Sequentially selects the input signal RGB/YBPBR, Video, or S-Video.
6. **LAMP indicator** [p.40](#)
Indicates the status of the lamp. Lights up or flashes when the lamp has developed a problem.
7. **TEMP indicator** [p.40](#)
Flashes red if the projector's temperature becomes too high.
8. **ON indicator** [p.40](#)
Lights up or flashes when the projector is under operation.
9. **Zoom ring** [p.27](#)
Adjusts the size of the image.
10. **Focus ring** [p.27](#)
Adjusts the focus of the projected image.

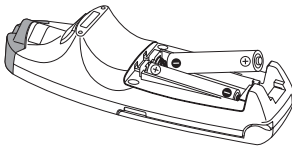
Preparing and using the remote control

■ Loading dry-cell batteries into the remote control

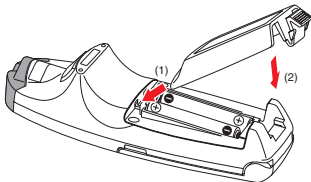
1. Remove the battery cover.



2. Insert the dry-cell batteries. Be sure to align the plus and minus ends of the batteries properly.



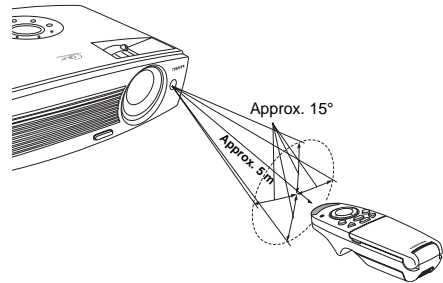
3. Replace the battery cover.



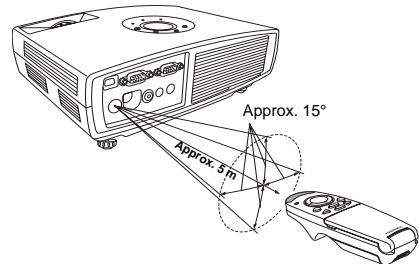
■ Operating the remote control

Point the remote control toward the projector's infrared remote sensor, and press a button on the remote control.

- Operating the projector from the front



- Operating the projector from the rear



■ Dry-cell batteries

- Remove batteries from remote control when not using for extended periods.
- If the remote control stops working, or if its range decreases, replace all the batteries with new ones.

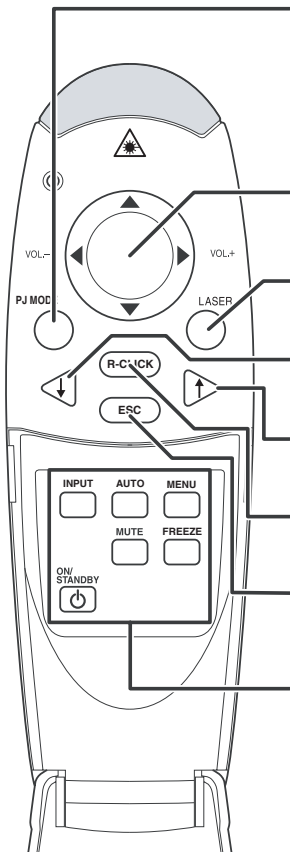
■ The remote control

- The remote control may fail to operate if the infrared remote sensor is exposed to bright sunlight or fluorescent lighting.
- Do not drop or bang.
- Do not leave in hot or humid locations.
- Do not get wet or place on top of wet objects.
- Do not take apart.
- In rare cases, ambient conditions could impede the operation of the remote control. If this happens, point the remote control at the main unit again, and repeat the operation.

Preparing and using the remote control (Continued)

■ Switching operation modes

Operation modes should be switched between projector operation and computer operation.



Switching the remote control operation mode. Pressing this button toggles the mode. When this button is lit, the remote control is in [PJ Mode] (Projector operation mode). If no operations are made for 30 seconds, this light goes out, and the remote switches back to [PC Mode] (Computer operation mode).

[PJ Mode] : Functions as a select button.

If no menu is displayed, adjusts volume.

[PC Mode] : Functions as a mouse pointer control.

Pressing displays a laser pointer, regardless of the mode.

[PC Mode] : Functions as a down button. Used to go forward on Microsoft® PowerPoint® slides, etc.

[PC Mode] : Functions as an up button. Used to go back on Microsoft® PowerPoint® slides, etc.

[PC Mode] : Functions as the right mouse button (R-CLICK).

[PC Mode] : Functions as a ESC button.

Pressing one of these buttons automatically sets the remote control to [PJ Mode]. If no operations are made for 30 seconds, and the remote switches back to [PC Mode].

The L-CLICK (left click) button on the back of the remote control functions when in [PC Mode].

■ Notes

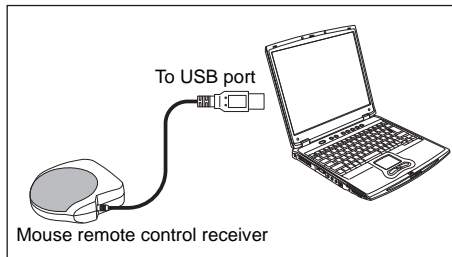
- With the exception of operating a PC with the remote control, all buttons are used in [PJ Mode].
- Make sure there is nothing between the remote control and the IR sensor on the projector that might obstruct the infrared beam.

Operating a computer using the remote control

A computer can be operated using the projector's remote control. This function is available on any computer with the Windows 98/98SE, Windows Me, Windows 2000, or Windows XP OS, that is equipped with a USB port supporting the USB 1.1 (The mouse remote control is supported on OS 9 or OS X for the Macintosh). The operation cannot be guaranteed for all the environments of computers.

1 Connecting a computer

Connect the supplied Mouse remote control receiver to the computer.



2 Operating a computer

The mouse remote control function is available when the remote control is set to [PC Mode]. (See "Switching operation modes".)

Point the Mouse remote control at the mouse remote control receiver, and operate the remote control's buttons.

- **Moving the mouse pointer**

Move the pointer control button in the direction that you wish the mouse pointer to move, then press.

- **To left click**

Press the L-CLICK button.

- **To right click**

Press the R-CLICK button.

- **To drag and drop**

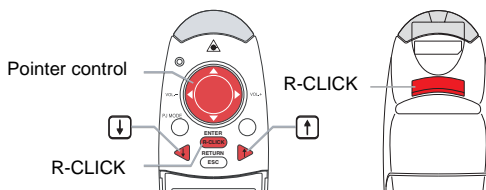
Move the pointer control button in a (L-)clicked state, then when the pointer is over the desired location, release the button.

- **Using the computer's up and down arrow key functions**

Press the ◀ and ▶ buttons to switch PowerPoint® slides.

Remote Control Front

Remote Control Rear



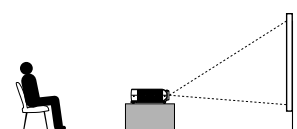

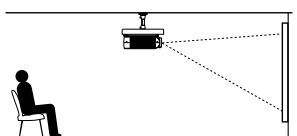

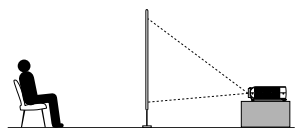

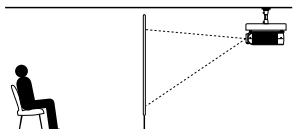
Positioning your projector

Choosing a location

Your projector is designed to be installed in one of four possible installation locations:

1. Floor in front of screen;
2. Ceiling in front of screen;
3. Floor at rear of screen;
4. Ceiling at rear of screen.

Your room layout or personal preference will dictate which installation location you select. Take into consideration the size and position of your screen, the location of a suitable power outlet, as well as the location and distance between the projector and the rest of your equipment.

<p>I. Floor front: Select this location with the projector placed near the floor in front of the screen. This is the most common way to position.</p>	
<p>II. Ceiling front: Select this location with the projector suspended from the ceiling in front of the screen. Set  in the Default setting > Projection mode menu after you turn the projector on.</p>	
<p>III. Floor rear: Select this location with the projector placed near the floor behind the screen. Set  in the Default setting > Projection mode menu after you turn the projector on.</p>	
<p>IV. Ceiling rear: Select this location with the projector suspended from the ceiling behind the screen. Set  in the Default setting > Projection mode menu after you turn the projector on.</p>	



WARNING

- Always obey the instructions listed in IMPORTANT SAFETY INSTRUCTIONS when placing the unit. Attempting to clean/replace the lamp at a high site by yourself may cause you to drop down, thus resulting in injury.
- If you wish to mount the projector on the ceiling, be sure to ask your dealer to do so. Mounting the projector on a ceiling requires special ceiling brackets (sold separately) and specialized knowledge. Improper mounting could cause the projector to fall, resulting in an accident.

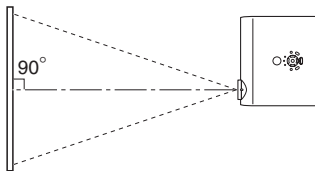
- If the projector is ceiling-mounted, install the breaker for turning off the power in case of anomaly. Let everyone involved with the use of the projector know that fact.

Projection distance and size

Use the figures, tables, and formulas below to determine the projection size and projection distance.

(Projection sizes are approximate values for full-size picture with no keystone adjustment.)

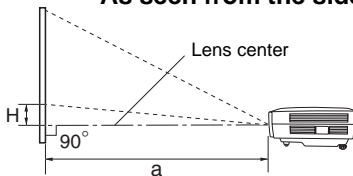
Screen **As seen from above**



$$a \text{ (min length)} = \frac{\text{projection size (inches)}}{30.03}$$

$$a \text{ (max length)} = \frac{\text{projection size (inches)}}{24.69}$$

As seen from the side



a is the distance (m) between the lens and the screen, and corresponds to a range of 1.15 m to 10.00 m. **H** is the height from the image bottom to the center of the lens.

projection size (inches)	projection distance a (m)		height (H) (cm)
	min length (zooming max)	max length (zooming min)	
30	1.00	1.22	7.54
36	1.20	1.47	9.05
40	1.33	1.63	10.06
60	2.00	2.44	15.09
80	2.66	3.26	20.12
100	3.33	4.07	25.15
150	5.00	6.11	37.72
200	6.66	8.14	50.29
250	8.33	10.18	62.87
300	9.99	---	75.44

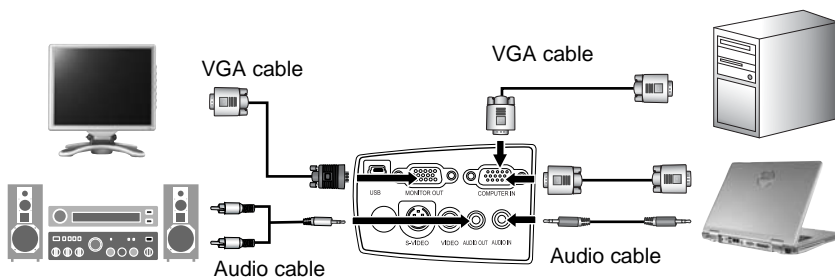
Connection

When connecting a signal source to the projector, be sure to:

1. Turn all of the equipment off before making any connections.
2. Use the correct signal cables for each source.
3. Ensure that the cables are firmly inserted.

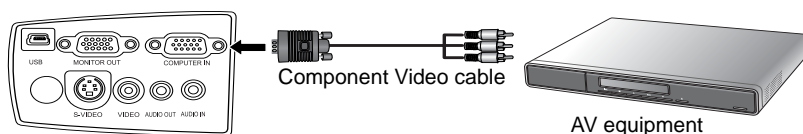
 **In the connections shown below, cables are not included with the projector (see [p.15](#)). Cables are commercially available from electronics stores.**

Connecting to a computer



- Signals are outputted from Monitor OUT terminal even in standby mode. From AUDIO OUT terminal, no audio signal is outputted.
- Many laptops do not turn on their external video ports when connected to a projector. Usually a key combination like FN + F5 or CRT/LCD key turns the external display on/off. Locate a function key labeled CRT/LCD or a function key with a monitor symbol on the laptop. Press FN and the labeled function key simultaneously. Refer to your laptop's documentation to learn your laptop's key combination.
- Audio out terminal accepts a stereo connector but signal is monaural.
- The output volume from the Audio out terminal can be adjusted by the volume buttons.

Connecting to a Component Video device

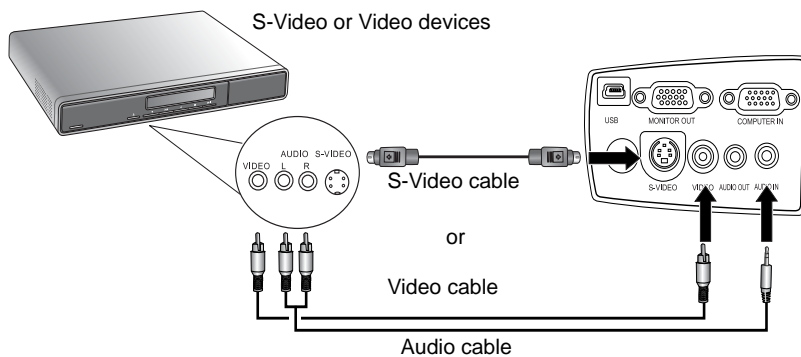


The projector is capable of accepting a Component Video signal. Use a Component Video-VGA (Mini D-sub) cable to display these images.

The following standards are supported in the digital TV function:

- 480i
- 576i
- 720p (50/ 60 Hz)
- 480p
- 576p
- 1080i (50/ 60 Hz)

Connecting Video and S-Video devices

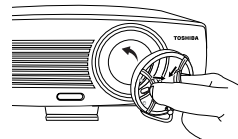
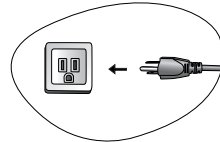


👉 If the selected video image is not displayed after the projector is turned on and the correct video source has been selected, check that the video source is turned on and operating correctly. Also check that the signal cables have been connected correctly.

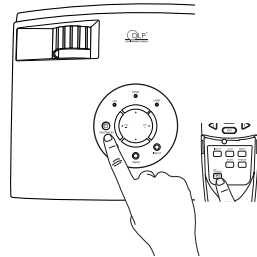
Operation

Start up

1. Switch all of the connected equipment on.
2. Plug the power cord into the projector and into a wall socket. Turn on the wall socket switch (where fitted). Check that the **ON indicator** on the projector lights orange after power has been applied.
3. Remove the lens cap. If it is left on, it could become deformed due to heat.



4. Press and hold the **ON/STANDBY** button on the remote control or projector to start the unit. The **ON indicator** flashes green and stays green when the unit is on.
5. The start up procedure takes about 20 seconds after pressing the **ON/STANDBY** button. In the later stage of start up, a default Toshiba logo is projected.
6. The projector will start to search for input signals. The projector screen displays the current input source being scanned at the upper left corner of the screen. If no input source signal is detected, the search will continue until an input source signal is detected.
7. You can also press the **INPUT** button on the projector or remote control to select an input signal to display. For more information, refer to [p.28](#).



 If the frequency/ resolution of the input signal exceeds the projector's operating range, you will see the message "Unsupported Signal" displayed on a blank screen.

CAUTION

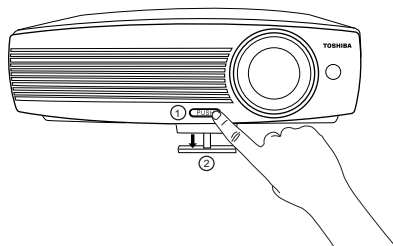
- Do not look into the lens while the lamp is on. The strong light from the lamp may cause damage to your eyes or sight.
- Do not block the air intake or exhaust. Doing so could cause a fire due to internal overheating.
- Do not place your hands, face, or other objects near the air exhaust. Doing so could cause burns, deform/break the object.

Adjusting the image

Adjusting the height

The projector is equipped with 1 quick-release adjuster foot and 1 tilt adjuster foot. The adjusters can be used to change the image height and projection angle. To adjust the projector to your desired image height and projection angle:

1. Lift the projector up to the desired angle and press the front adjuster button to release the adjuster. The adjuster will drop into position.
2. Screw the tilt adjuster foot to fine tune the horizontal angle.

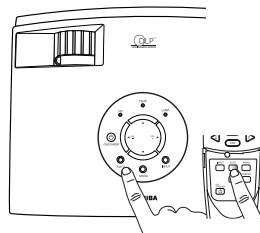


To retract the feet, hold up the projector while pressing the front adjuster button, then slowly lower the projector. Screw the rear adjuster foot in a reverse direction.

If the screen and the projector are not perpendicular to each other, the projected image becomes vertically trapezoidal. To correct this situation, adjust the value of Keystone in the Picture menu, on the projector control panel or on the remote control.

Auto-adjusting the image

In some cases, you may need to optimize the picture quality. To do this, press the **AUTO** button on the control panel of the projector or on the remote control. Within 5 seconds, the built-in Intelligent Auto Adjustment function will re-adjust the values of Frequency, and Clock to provide the best picture quality.

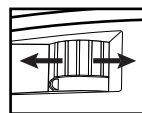
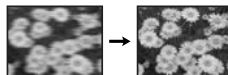
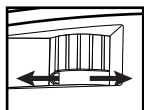
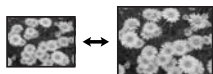


This function is only available when the Computer input is selected.

The screen will be blank while the auto-adjustment is functioning.

Fine-tuning the image size and clarity

1. Adjust the projected image to the size that you need using the zoom ring.
2. Then sharpen the image by rotating the focus ring.



Adjusting the volume

The speaker volume can be adjusted when an audio signal is being input.


Correcting keystone

Keystone distortion refers to the situation where the projected image is noticeably wider at either the top or bottom. It occurs when the projector is not perpendicular to the screen.

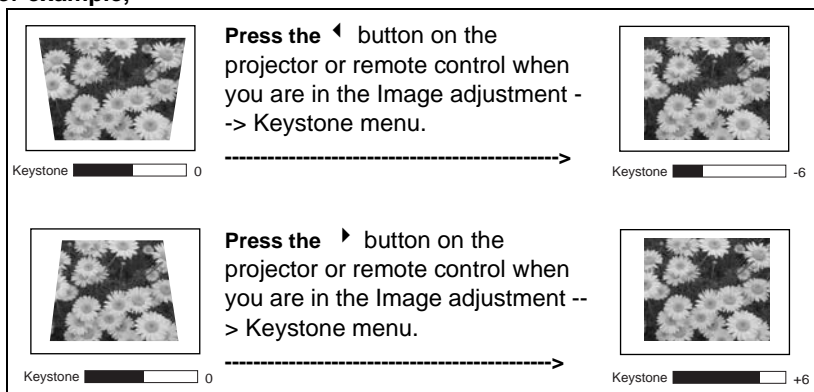
To correct this:

1. Adjust the position of the projector.
2. Press the **AUTO** button on the remote control or the projector.

If the image is still distorted, you will need to manually correct it following steps.

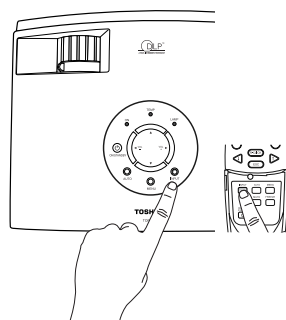
- Press the MEMU button on the projector or the remote control. Go to the Image adjustment  --> Keystone menu and adjust the values by pressing ◀ / ▶ button on the projector or remote control.

For example,



Switching input signals

The projector can be connected to multiple devices at the same time. To sequentially select input sources, press the **INPUT** button on the projector control panel or the remote control. The selected input signal will be displayed at the upper left corner of the screen for 5 seconds.

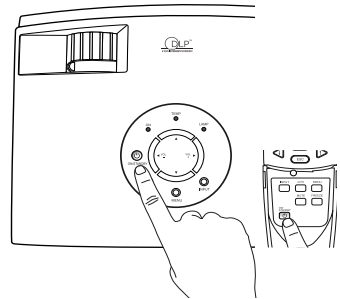


Shutdown

1. Press **ON/STANDY** and a confirmation prompt displays. Press **ON/STANDY** a second time to turn the projector off.
2. The **ON indicator** flashes orange and the lamp shuts down. The fans will continue to run for approximately 90 seconds to cool down the projector lamp.

Press the [ON/STANDBY] button again to turn off.

- **To protect the lamp, the projector will not respond to any commands during the cooling process.**
- **Do not unplug the power cord before the projector shutdown sequence is complete or during the 90-second cooling down process.**



Note

- Note that a lamp characteristics may rarely cause the brightness to fluctuate slightly.
- A lamp is consumable item. If used for extended periods, images will appear dark, and the lamp could burn out. This is characteristic of a lamp, and is not malfunction. (The lifetime of the lamp depends on conditions of use.)
- The DMD™ is made using extremely advanced technology, but there may be black spots (pixels that do not light) or bright spots (pixels that are constantly lit) on the panel. Please note that these are not malfunctions.





CAUTION

- **Do not block the projection lens from projecting as this could cause the blocking object to become heated and deformed.**
- **Do not look into the lens while the lamp is on. The strong light from the lamp may cause damage to your eyes or sight.**
- **Do not block the air intake or exhaust. Doing so may cause damage to the projector due to internal overheating.**
- **Do not place your hands, face, or other objects near the air exhaust. Doing so may cause burns, deform/break the object.**

Menu operation

Menu system

The OSD menus will vary according to the selected signal type being used.

	Functions available when receiving different signal types...	
Sub-Menu	PC	Video / S-Video / Component Video
 Image adjustment menu	Picture mode Keystone Brightness Contrast H-position V-position Phase Frequency	Picture mode Keystone Brightness Contrast Color Tint Sharpness
 Display setting menu	Volume OSD time Reset all Screen size Aspect ratio	Volume OSD time Reset all Screen size Aspect ratio
 Default setting menu	Projection mode Auto input search Language Start-up screen Fan mode Power on	
 Information menu	Input Resolution Picture mode Lamp time	Input Video mode Picture mode Lamp time

Using the menus

The projector is equipped with on-screen display (OSD) menus for making various adjustments and settings.

The following example describes the adjustment of the keystone.

1. Press the **MENU** button on the projector or remote control to turn the on-screen menu on.
3. Adjust keystone values by pressing **◀ / ▶** on the projector or remote control.

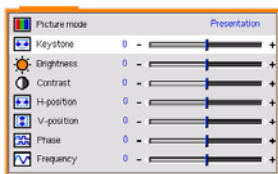


2. Use **◀ / ▶** button on the projector or on the remote control to select

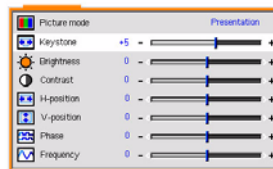



Image adjustment and

press **▲** or **▼** button to select **Keystone**.



4. Press the **MENU** button to leave and save the settings.

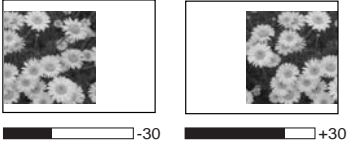
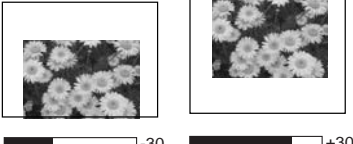



There are 10 different menu languages. Before making adjustments, you may choose a suitable OSD language in the **Default setting**  **> Language** menu. (Refer to [p.34](#) for more details.)

1. Image adjustment menu


- ☐ Some picture adjustments are available only when certain input ports are in use. Unavailable adjustments are not shown on the screen.

FUNCTION	DESCRIPTION
Picture mode	<p>Picture modes are provided so you can optimize your projector image set-up to suit your program type.</p> <ul style="list-style-type: none"> • PC Signal Input <ol style="list-style-type: none"> 1. Bright: The brightness is emphasized in this mode. 2. Standard: The color saturation and brightness are well-balanced. 3. True color: Displaying images in their natural color. 4. Economic: Use this mode to reduce system noise and reduce power consumption by 20%. The lamp life is also extended with lower light output. (*) • YPbPr/ S-Video/ Video Signal Input <ol style="list-style-type: none"> 1. Standard: It is suitable for enjoying TV movies. 2. Cinema: With a lower color temperature, it is suitable for enjoying cinematic movies. 3. Economic: Use this mode to reduce system noise and reduce power consumption by 20%. The lamp life is also extended with lower light output. (*) <p>*Economic mode is effective from the next power on after turn off (standby) the projector.</p>
Keystone	<p>Corrects any keystone distortion of the image. Refer to p.28 for more information.</p>
Brightness	<p>Adjusts the brightness of the image. The higher the value, the brighter the image. And lower the setting, darker the image. Adjust this control so the black areas of the image appear just as black and that detail in the dark areas is visible.</p> <div data-bbox="624 970 1005 1074"> </div>
Contrast	<p>Adjusts the degree of difference between dark and light in the image. The higher the value, the greater the contrast.</p> <div data-bbox="624 1214 1005 1318"> </div>

H-position	Adjusts the horizontal position of the projected image.	
V-position	Adjusts the vertical position of the projected image.	
Phase	This function allows you to adjust the clock phase to reduce image distortion.	
Frequency	Adjusts the horizontal width of the image.	
Color	Increases or decreases the color intensity of the image.	
Tint	Adjusts the color tones of the image.*	
Sharpness	Adjusts the image to make it look sharper or softer.	

* Tint can be displayed and adjusted only when the video signal is set to NTSC or NTSC 4.43.

2. Display setting menu

-  Some picture adjustments are available only when certain input ports are in use. Unavailable adjustments are not shown on the screen.

FUNCTION	DESCRIPTION
Volume	Adjusts the volume level.
OSD Time	Sets the length of time the OSD will remain active after your last button press. The range is from 5 to 60 seconds.
Reset all	Returns all settings to the factory preset values.
Screen size	Makes the best fit of the image to the screen. 1. Full 2. Through
Aspect ratio	There are two aspect ratio settings. 1. 4 : 3 (Standard) 2. 16 : 9 (Wide screen)

3. Default setting menu

FUNCTION	DESCRIPTION
Projection mode	The projector can be installed on a ceiling or behind a screen, or with one or more mirrors. Contact your dealer for the ceiling mount bracket (optional accessory) if you need to install the projector on your ceiling. For more information, refer to p.22 .
Auto input search	Sets whether the projector searches automatically for input signals. If the source scan is on, the projector will scan for input signals until it acquires a signal. If the function is not activated, the projector selects the last used input signal.
Language	Language sets the language for the OSD control menus. Use ◀ / ▶ button on the projector or remote control to select your desired language from among English, French, German, Italian, Spanish, Russian, Traditional Chinese, Simplified Chinese, Japanese, and Korean.
Start-up screen	Enables the user to select which logo screen will appear during projector start-up. Three modes are available: Default (Toshiba logo), black screen or blue screen.
Fan mode	A mode used for extreme environments like high altitude. We recommend you set High when your environment is higher than 3000 feet above sea level. Press ◀ or ▶ button on the projector or remote control to select. Operation under high fan mode may cause a higher decibel operating noise level because of increased fan speed necessary to improve overall system cooling and performance. If you use this projector under other extreme environments excluding the above, it may display auto shut-down symptoms, which is designed to protect your projector from over-heating. In cases like this, you should switch to High fan mode to solve these symptoms. However, this is not to state that this projector can operate under any and all harsh or extreme environments.
Power on	Set whether to turn on the power when the ON/STANDBY button is pressed (Manual), or when the power cord is plugged in (Auto).

4. Information menu


This menu shows you the current operating status of the projector.

FUNCTION	DESCRIPTION
Input	Shows the current signal source.
Resolution	Shows the native resolution of the input signal.
Picture mode	Shows the selected mode in the Image adjustment menu.
Lamp time	Displays the number of hours the lamp has been used.
Video mode	Shows the Video input system format, NTSC, SECAM or PAL.

Additional Information

Care of the projector

To care for your projector, clean the lens and projector case on a regular basis, following the instructions below.

-  **Never remove any parts of the projector except the user-replaceable lamp. Contact your dealer if other parts need replacing.**

Cleaning the lens

WARNING

- Request cleaning and maintenance of a ceiling-mounted unit from your projector dealership. Attempting to clean/replace the lamp at a high site by yourself may cause you to drop down, thus resulting in injury.

Clean the lens whenever you notice dirt or dust on the surface.



CAUTION: HOT SURFACE! Before cleaning the lens, turn the projector off, unplug the power cord, and allow the projector to cool for at least one hour.

1. Use a canister of compressed air to remove dust (available from building hardware or photographic suppliers).
2. If there is stubborn dirt or smudge marks, use a photographic lens brush or a clean, soft lens cloth (moistened with lens cleaner, if necessary) to gently wipe the lens surface.

NEVER touch the lens with your bare hands or rub the lens with abrasive materials (products such as paper towels can damage the lens coating). ALWAYS use a photographic lens brush or lens cleaning cloth and solution. NEVER attempt to clean the lens while the projector is on or while it is still hot from previous use.

Cleaning the projector case



CAUTION: HOT SURFACE! Before cleaning the lens, turn the projector off, unplug the power cord, and allow the projector to cool for at least one hour.

1. To remove dirt or dust, wipe the case with a soft, dry, lint-free cloth.
2. If the soiling is severe, dip the cloth in a neutral detergent diluted in water, wring well, and gently wipe off the dirt, then finish up by wiping with a dry cloth.

Never use wax, alcohol, benzene, thinner, or other chemical detergents. These products can damage the case.

Storing the projector

If you need to store the projector for an extended time, follow these guidelines:

1. Make sure the temperature and humidity of the storage area are within the recommended range for the projector. Please refer to the Specifications page in this manual or consult your dealer.
2. Retract the adjuster feet.
3. Remove the batteries from the remote control.
4. Pack the projector in its original packing or equivalent packing materials.

Transporting the projector

Ship the projector in its original packing. If you carry the projector yourself, use the supplied soft carrying case.

About the lamp

The product's light source is a mercury lamp that lights at increased internal pressure. Be sure to fully understand the following characteristics of the lamp and handle it with extreme care.

- The lamp may burst with a loud noise due to impact or deterioration, or fail to light at the expiration of its life.
- How long it takes before the lamp bursts or the life expires may vary greatly by lamp. Some may burst shortly after first use.
- Burst is likely to happen if the lamp is used after the replacement period has elapsed.
- When the lamp bursts, the broken pieces of glass may get inside the product or be released outside from the openings for ventilation.
- When the lamp bursts, a slight amount of mercury gas enclosed in the lamp along with glass dust may be released from the openings for ventilation.


■ Replace the lamp when a sign appears on the screen.


- When the replacement time approaches, the message will appear on the screen.
- The risk of burst will increase if the lamp is continuously used without being replaced.
- Frequently check the used hours and prepare spares when the replacement time approaches.

■ When the lamp is broken

- If glass components, including a lamp and a lens, should break, handle the broken pieces with care to avoid injury and contact your dealer for repair service.
- In the event of lamp burst, unplug the product from the wall outlet, leave and completely ventilate the room. Then, thoroughly clean the area around the projector and discard any edible items placed in that area.
- When the lamp bursts, consult a doctor if glass dust or mercury gas gets into your eyes or you breathe it.

Lamp warning message

The following Lamp warning displays will remind you to change the lamp. The lamp hour information is also available in the **Information**  > **Lamp time** menu.

Message	Status
	<p>The lamp has been in operation for 2000 hours. Install a new lamp for optimal performance.</p>

Replacing the lamp



CAUTION: HOT SURFACE! The lamp may be very hot after use. Before replacing the lamp, turn off the projector, unplug the power cord, and allow the projector to cool for at least 45 minutes.



The lamp unit contains mercury. Disposal of mercury may be regulated due to environmental considerations. Dispose of the used lamp unit by the approved method for your area. Contact your local authorities or www.eiae.org (USA only).

A lamp is consumable supplies. If used for extended periods, images will appear dark, and the lamp could burn out. This is characteristic of a lamp, and is not malfunction. (The lifetime of the lamp depends on condition of use.) If this happens, replace it with a new one.

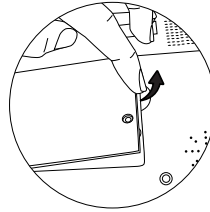
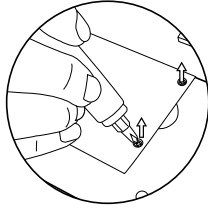
WARNING

- If the projector is mounted on the ceiling, ask your Toshiba dealership to replace the lamp. Replacing the lamp at a high site by yourself may cause you to drop down, thus resulting in injury.
- When replacing, always use lamp “TLPLW7” (sold separately).

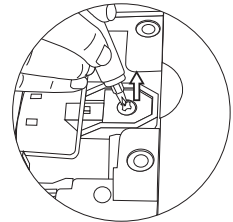
CAUTION

- If you have been using the projector, the lamp will be very hot, and may cause burn injuries. Wait for the lamp to cool (for at least 45 minutes) before replacing it.
- If the lamp should break, please handle with care to avoid injury due to broken pieces and contact your dealer for repair service.

- Step 1. Turn the power off and disconnect the projector from the wall socket.
- Step 2. Protect the projector's surface by clearing a flat open area on your desk and placing a soft item on the desk for padding.
- Step 3. Turn the projector over. Then loosen the screws and remove the lamp cover. If the lamp is hot, avoid burns by waiting for 45 minutes until the lamp has cooled.

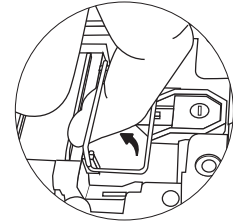


- Step 4. Loosen the screw fixing the lamp to the projector. If the screw is not loosened completely, the lamp cannot be removed. Be careful not to lose the screw as it is needed to hold the replacement lamp in place. It is strongly recommended that you use a magnetic-head screwdriver.



- Step 5. Lift the handle so that it stands up. Use the handle to slowly pull the lamp out of the projector.

- ☞ **Pulling it too quickly may cause the lamp to break and scatter broken glass in the projector.**
- **Do not place the lamp in locations where water might splash on it, children can reach it, or near flammable materials.**
- **Do not insert your hands into the projector after the lamp is removed. If you touch the optical components inside, it could cause color unevenness and distortion of the projected images.**



- Step 6. Insert a new lamp. Ensure the handle is fully laid flat and locked in place. Reinsert and tighten the screw firmly.

- ☞ **Loose screw may cause a bad connection, which could result in malfunction.**
- **Do not over tighten the screw.**

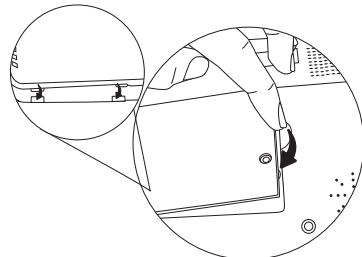
- Step 7. Reinstall the lamp cover and tighten the screws.

- Step 8. Restart the projector.

- ☞ **Do not turn the power on with the lamp cover removed.**

- Step 9. **Resetting the lamp counter**
See the lamp's manual for instructions on resetting the lamp timer.

- ☞ **Do not reset if the lamp is not replaced as this could cause damage.**



Indicator lights

The front of the projector has three lights that indicate its status. Check the following for information about the indicator lights. If an abnormal condition is indicated, turn off the projector and contact your dealer.

When the projector is in a normal state:

POWER	TEMP	LAMP	State	Remark
Orange	Off	Off	Standby mode	---
Flashing Green	Off	Off	The projector is powering up.	Cannot turn off the projector.
Green	Off	Off	The projector is under normal operation.	---
Flashing Orange	Off	Off	The projector needs to cool down for 90 seconds after the power is turned off.	Cannot turn on the projector.

When the projector is in an abnormal state:

POWER	TEMP	LAMP	State	Remark
Off	Off	Red	The lamp has exceeded its usage life.	Solution: • Install a new lamp.
Red	Red	Off	The internal temperature is too high. • The intake ventilation or the exhaust ventilation is blocked. • The projector may be in a poorly ventilated location. • The ambient temperature may be too high. The fans are not working.	Solution: • Make sure the ventilation holes are not blocked. • Relocate the projector. • Stop using the projector until the ambient temperature falls within the specified range. The maximum operating temperature is specified as 35°C (95°F). • Make sure the power supply is stable. • Check if there is an object stuck in the fans. • Contact your dealer.
Red	Red	Green		
Red	Red	Red		
Off	Red	Off		
Off	Red	Green		
Green	Red	Off		
Green	Red	Green		

Troubleshooting

Problem	Cause	Remedy
The projector does not turn on.	There is no power from the power cord.	Plug the power cord into the AC inlet on the projector, and plug the power cord into to a power outlet. If the power outlet has a switch, make sure it is switched on. p. 26
	Attempting to turn the projector on again during the cooling process.	Wait until the cooling-down process is completed.
	The lamp cover is not securely attached.	Correctly attach the lamp cover.
No picture.	The video source is not turned on or connected correctly.	Turn the video source on and check that the signal cable is connected correctly. p. 23
	The projector is not correctly connected to the input source device.	Check the connection. p. 23
	The input signal has not been correctly selected.	Select the correct input signal with the INPUT buttons on the remote control or INPUT on the projector. p. 28
Image is unstable.	The connection cables are not securely connected to the projector or the signal source.	Correctly connect the cables to the appropriate terminals.
Picture is blurred.	The projection lens is not correctly focused.	Adjust the focus of the lens using the focus ring. p. 27
	The projector and the screen are not aligned properly.	Adjust the projection angle and direction as well as the height of this unit if necessary. p. 27
	The lens cap is still attached to the lens	Remove the lens cap.
Remote control does not work correctly	The batteries are out of power.	Replace both of the batteries with new ones. p. 19
	There is an obstacle between the remote control and the projector.	Remove the obstacle.
	You are too far away from the projector.	Stand within 5 meters (16.4 feet) of the projector. p. 19

Specifications

Projector specifications

 All specifications are subject to change without notice.

General

Product name	DATA Projector
Model name	TDP-P75

Optical

Display system	1-CHIP DMD 1024 x 768 XGA
Lens F/Number	F=2.4 to 2.6, f= 18.6 to 22.7 mm
Lamp	200W lamp

Electrical

Power supply	AC100 ~ 240V, 3.5A, 50/60 Hz (Automatic)
Power consumption	280 W (Max)

Mechanical

Dimensions	238 mm (W) x 86.8 mm (H) x 180 mm (D)
Weight	4.2 lbs (1.9 Kg)

Input terminal

RGB/ YPBPR input	Mini D-sub 15-pin (female)
S-VIDEO	Mini DIN 4-pin port x 1
VIDEO	RCA x 1
Audio in	Mini stereo
USB	Mini type B (Service purpose only)

Output terminal

Monitor out	Mini D-sub 15-pin (female)
Audio out	Mini stereo (variable)

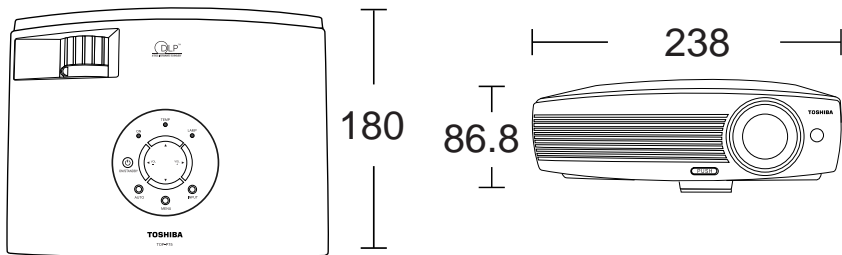
Output

Speaker	1 watt x 1
---------	------------

Environmental requirements

Operating altitude and temperature	0~35°C for height: 0~2,500 feet
	0~30°C for height: 0~2,500~3,000 feet
	0~30°C for height: 3,000~10,000 feet (Please switch the High fan speed mode on.)
Operating relative humidity	10% ~ 90% (without condensation)

Dimensions




Unit: mm

Signal timing

Supported timing for PC input

Resolution	Horizontal Frequency (kHz)	Vertical Frequency (Hz)	Pixel Frequency (MHz)	Mode
720 x 400	37.927	85.039	35.500	720 x 400_85
640 x 480	31.469	59.940	25.175	VGA_60
	37.861	72.809	31.500	VGA_72
	37.500	75.000	31.500	VGA_75
	43.269	85.008	36.000	VGA_85
800 x 600	37.879	60.317	40.000	SVGA_60
	48.077	72.188	50.000	SVGA_72
	46.875	75.000	49.500	SVGA_75
	53.674	85.061	56.250	SVGA_85
1024 x 768 (native)	48.363	60.004	65.000	XGA_60
	56.476	70.069	75.000	XGA_70
	60.023	75.029	78.750	XGA_75
	68.667	84.997	94.500	XGA_85
1280 x 1024	63.981	60.020	108.000	SXGA3_60

 To achieve the best quality projected image, please use the projector's native resolution of 1024 x 768.

Supported signal format for Component-YPBPR Input

Signal Format	Horizontal Frequency (kHz)	Vertical Frequency (Hz)
480i(525i)@60Hz	15.73	59.94
480p(525p)@60Hz	31.47	59.94
576i(625i)@50Hz	15.63	50.00
576p(625p)@50Hz	31.25	50.00
720p(750p)@60Hz	45.00	60.00
720p(750p)@50Hz	37.50	50.00
1080i(1125i)@60Hz	33.75	60.00
1080i(1125i)@50Hz	28.13	50.00

Supported signals for Video and S-Video inputs

Video mode	Horizontal Frequency (kHz)	Vertical Frequency (Hz)	Color sub-carrier Frequency (MHz)
NTSC	15.73	60	3.58
PAL	15.63	50	4.43
SECAM	15.63	50	4.25 or 4.41
PAL-M	15.73	60	3.58
PAL-N	15.63	50	3.58
PAL-60	15.73	60	4.43
NTSC4.43	15.73	60	4.43

Regulation statements

FCC statement

CLASS B: This equipment generates, uses and can radiate radio frequency energy and, if not installed and used in accordance with the instructions, may cause harmful interference to radio communications. However, there is no guarantee that interference will not occur in a particular installation. If this equipment does cause harmful interference to radio or television reception, which can be determined by turning the equipment off and on, the user is encouraged to try to correct the interference by one or more of the following measures:

- Reorient or relocate the receiving antenna.
- Increase the distance between the equipment and receiver.
- Connect the equipment into an outlet on a circuit different from that to which the receiver is connected.
- Consult the dealer or an experienced radio/TV technician for help.

EEC statement

This machine was tested against the 89/336/EEC (European Economic Community) for EMC (Electronic Magnetic Compatibility) and fulfills these requirements.

MIC statement

B class equipment (Household purpose info/telecommunications equipment)

As this equipment has undergone EMC registration for household purpose, this product can be used in any area including residential area.